



Mains-Fed Water Cooler
Countertop / Freestanding

C7 Firewall®

High-end bottle-free water dispenser with excellent purifying performance and stylish design, providing a superior user experience

- This advanced touch-free dispenser caters to various demanding environments, from offices to healthcare, providing up to five water varieties.
- Firewall® safely purifies water up to 99.9999% bacteria-free and 99.99% virus-free.
- Featuring coloured LCD display and offering up to 5 water types in one unit.



Product features and benefits



Cutting-edge design

High-tech features in a robust and reliable machine, designed to perform in demanding environments.

The 273 mm dispensing gap can accommodate a variety of vessels, including reusable bottles.

Generous 440 ml drip tray capacity to collect accidental spillage.

Standby mode significantly reduces power consumption when the unit is not in use.

A lockable base cabinet, supplied with universal keys, transforms the unit from countertop to freestanding and provides additional storage space for filters and CO2 bottles.



Unrivaled water treatment technology

Patented Firewall® UV-C purification technology guarantees microbiologically safe water by deactivating up to 99.9999% bacteria, 99.99% viruses, and 99.9% cysts.

The innovative Ice Bath water cooling system delivers high volumes of ice-cold water, offering a consistently cold/ sparkling water output.

The product line uses R600a, a naturally occurring refrigerant gas that does not contribute to global warming, in addition to offering greater energy efficiency with the use of a quieter compressor.

1.8
L/M

FLOW RATE



User-friendly and hygienic operations

The user interface, equipped with a full-color LCD display showcasing a machine status bar and a touch-enabled dial offering up to five water dispensing options, is designed to provide the best-in-class user experience.

The key plastic surfaces are infused with BioCote®, a silver ion additive that provides continuous antimicrobial protection against a broad spectrum of bacteria, mould and fungi, and reduces the risks of cross-contamination.

Contact-free dispensing operations for greater hygiene activated by the optional add-on IR (infrared) module.

An on screen bottle-saver counter tracks the positive impact on the environment by counting how many 500 ml plastic bottles users have saved by using this bottle-free dispenser.

Backlit waterfall vertical indicator for accurate vessel positioning.

Leak prevention system automatically cuts off the water supply, reducing the risk of accidents.

Two-steps action hot water safety mechanism can help to avoid accidental spillage.

99.9999%







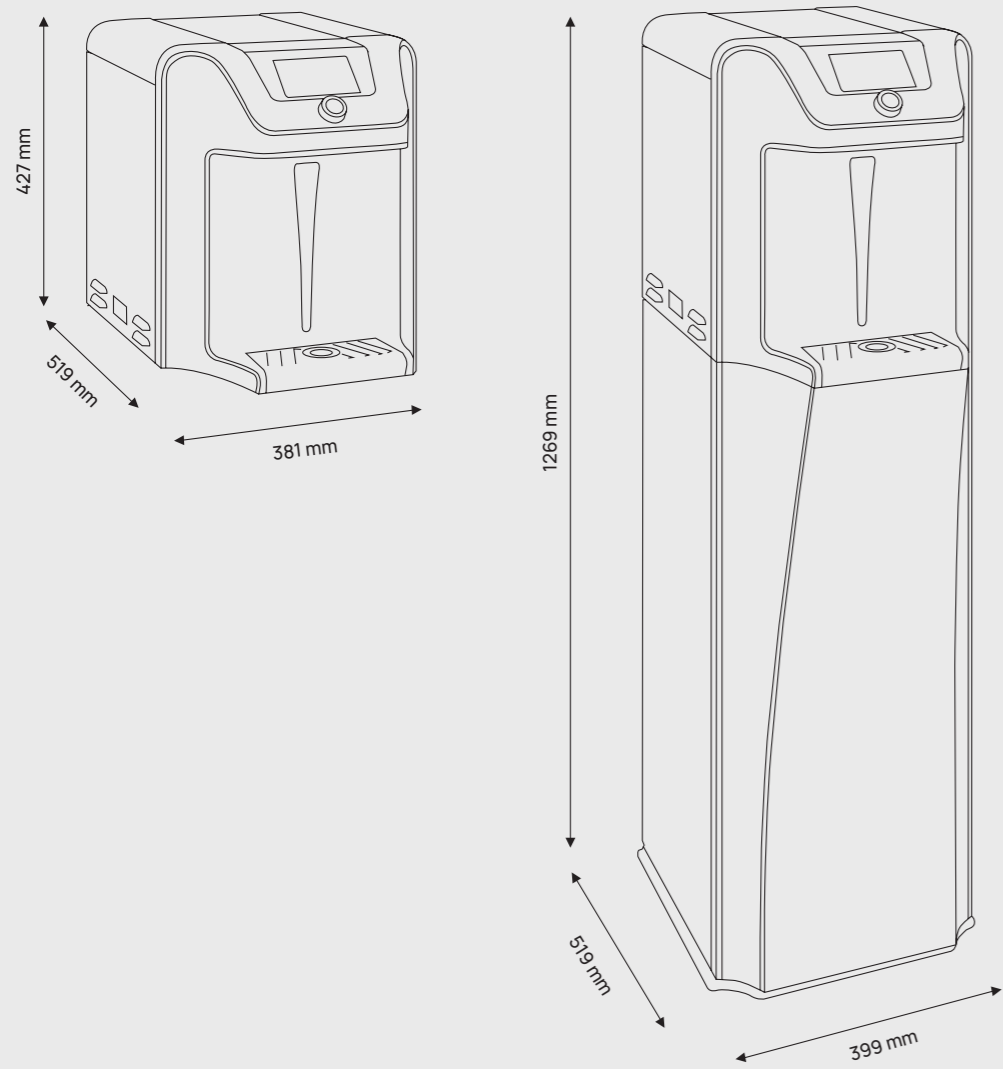





Firewall® UV-C technology thoroughly purifies the water all the way through to the dispense point.



Technical specifications



Water options

Ambient	Cold	Sparkling	Hot	Extra hot
				
				
				

Specifications

Model	Countertop	Freestanding
Dimensions	381mm (W) x 519mm (D) x 427mm (H)	399mm (W) x 3519mm (D) x 1269mm (H)
Weight	33.3 Kg (countertop)	33.3 Kg (countertop) / 20 Kg (base cabinet)
Dispense (area) height	273 mm	
Drip tray capacity	440 ml	

Technology and performance

Water purification system	Firewall UVC technology
Recommended filtration	Carbon CBC or GAC depending on incoming water conditions (internal installation, not included with the product)
Refrigerant gas	R600a
Cooling technology	Ice bath
Tank	Hot water: 1.5 L / Cold water: Ice bath
Dispensing capacity (flow rate)	1.8 L/m
Min/max water temperature	Cold: 0°C / Hot: 93°C
Noise level	35 dB
Operating pressure	3 bar
CO2 operating pressure	3 - 4 bar
Max electrical consumption	993 W

Installations requirements

Power supply	220~240 V/50 Hz
Compressor power	1/8 HP
Water connection	1/4"
Ventilation space	10 cm

CulliganTM
Water you love.

culligan.com
+1111 222 2222
email@culligan.com

