

Quick Start Installation Guide

# Zip HydroTap G5



Command Centre  
Boiling, Boiling / Ambient models



AFFIX PRODUCT LABEL HERE



Australia



UK

Visit our website to  
download the manuals

## Table of contents

SECTION 1: Using these instructions .....	3
SECTION 2: IMPORTANT SAFETY INSTRUCTIONS.....	4
SECTION 3: WARNINGS & REGULATORY INFORMATION.....	6
SECTION 4: Technical data .....	8
SECTION 5: Parts supplied .....	9
SECTION 6: Set up the ventilation .....	10
SECTION 7: Connect the water supply .....	12
SECTION 8: Set the bypass & install the Limescale filter .....	13
SECTION 9: Fit the Booster.....	14
SECTION 10: Connect the Booster .....	15
SECTION 11: Connect the Command Centre.....	16
SECTION 12: Commissioning .....	19

## SECTION 1: Using these instructions

### Before you start



This document is a Quick Start Installation Guide.  
For further details on installing and operating your HydroTap,  
download & read the Command Centre installation and user  
instructions, which can be found online at:  
(Australia) [www.zipwater.com](http://www.zipwater.com)  
(UK) [specify.zipwater.co.uk](http://specify.zipwater.co.uk)



Read and use the instructions supplied with individual kit  
components for a safe installation.

### Explanation of symbols



Read the  
instructions



WARNING



Danger of  
electric shock



Hot surface

## SECTION 2: IMPORTANT SAFETY INSTRUCTIONS



### Compliance

In Australia electrical installation must comply with AS/NZS3000.

In Australia plumbing installation must comply with AS/NZS3500.

In the UK the system must be installed in accordance with water supply byelaws, current IEE regulations and local authority byelaws.

### Safety

This appliance is not intended for use by children under 8 years or persons (including children under 8 years) with reduced physical, sensory or mental capabilities, or lack of experience and knowledge, unless they have been given supervision or instruction concerning the use of the appliance by a person responsible for their safety. Children should be supervised to ensure that they do not play with the appliance.

### Qualifications

To avoid hazards, all installation procedures must be carried out by a suitably qualified tradesperson. The power cable and power outlet must be in a safe visible position for connection.

### Venting

Sometimes steam and / or boiling water droplets may discharge through a vent outlet on the tap. If not using the font, ensure the tap body is located so the tap outlet safely dispenses into the sink bowl.

### Lifting

Take care when lifting. The Command Centre may exceed safe lifting limits.

If you feel this is beyond your personal capabilities, please seek assistance with the lift. The weight of the Command Centre is marked on the packaging. Do not lift the Command Centre by the front cover or any of its connections.

### Airflow

The Zip HydroTap operates within the ambient temperature range 5°C

## SECTION 2: IMPORTANT SAFETY INSTRUCTIONS

- 35°C. Proper air circulation must be provided. The system will operate satisfactorily only if the recommended air gaps are provided. The vent kit supplied must be fitted.

### Altitude

Water boils at varying temperatures at different altitudes. The HydroTap adjusts for this during startup calibration and will recalibrate itself on a regular basis.

### Frost protection

If the HydroTap is located where the ambient air temperature could fall below 5°C when the system is not in use, do not turn off the Command Centre electrically. This safeguard does not offer the same protection to the connecting pipework and fittings.

### Application

The HydroTap G5 Home series is intended to be used in household and similar applications such as:

- Staff kitchen areas in shops, offices and other working environments;
- Farm houses and by clients in hotels, motels and other residential type environments;
- Bed and breakfast type environments;
- Catering and similar non-retail applications.

## SECTION 3: WARNINGS & REGULATORY INFORMATION



- For continued safety of this appliance it must be installed, operated and maintained in accordance with the manufacturer's instructions.
- This appliance may deliver water at high temperature. Refer to the Plumbing Code of Australia (PCA), local requirements and installation instructions to determine if additional delivery temperature control is required.



-  The Zip HydroTap must be earthed. Earthing is provided via the supplied power cord. The resistance of the earth connection to each exposed metal part must be less than 1Ω. Use the power cable supplied. It is the responsibility of the installer to ensure the power point is earthed.
- All installation and service work must be completed by trained and suitably qualified tradespeople. Faulty operation due to unqualified persons working on this product may void warranty coverage.
- As the installer, it is your responsibility to supply and install all valves as required by local regulations and relevant standards.
- The HydroTap is rated for 220-240V 50Hz AC operation.
- Do not remove the cover of the appliance under any circumstances without first isolating the appliance from the power supply.
- Connect only to a potable (wholesome, cat1) mains water supply.
- The new hose sets supplied with the product must be used. Do not re-use old hose sets.
- Never locate the system near, or clean with water jets.
- Do not expose the Zip HydroTap to the elements of nature.
- The booster complies with protection class IP 20.
- For UK, a pressure limiting valve must be fitted for mains water pressures above the maximum limits stated.

## SECTION 3: WARNINGS & REGULATORY INFORMATION

- Use of tools can be hazardous. Assess the risks before you start.
- A clearance envelope around all Command Centres must be provided to allow adequate ventilation for the safe and effective use of the HydroTap system.
- Valve and fitting threads must be sealed appropriately with PTFE tape where compression seals are not provided.
- Always flush new filter before use.
- Do not connect Booster to electrical supply until commissioning.
- Do not over tighten plumbing and hose connections.
- Braided hoses supplied cannot be lengthened.
- The power cord and general power outlet must be in a safe and accessible position after installation. When positioning the appliance, ensure the power supply cord is not trapped or damaged. If the power supply cord is damaged it must be replaced by a Zip service provider or a qualified electrician.
- Do not locate multiple portable socket-outlets or portable power supplies at the rear of the appliance.
- For safe operation, the HydroTap is designed to be installed, commissioned and used within 48 hours. Should the HydroTap not be required for an extended period of time (72 hours or more), do not fill and commission the HydroTap until ready for first use.
- For water taste and quality reasons, following any non-use period of more than 72 hours, Zip recommends to perform a system flush. Failure to flush the system may affect water quality.
- For UK, this appliance incorporates adequate backflow prevention in accordance to S.I.1999 No.1148 The Water Supply (Water fittings) Regulations 1999 Schedule 2 requirement. No further backflow prevention is required for connection to the water supply.
- For UK, this appliance only contains materials that conform to the requirements of BS6920:2014 'Suitability of non metallic materials and products for use in contact with water intended for human consumption with regard to their effect on the quality of water'.

## SECTION 4: Technical data

Component	Power rating kW	Dimensions W x D x H (mm)	Weight (kg)
B100, BA100	1.8 + Booster	280 x 313 x 333	13
B60, BA60	1.8	280 x 313 x 333	13
B, BA Home	1.35	280 x 313 x 333	13

### Electricity supply requirements

220-240V 50Hz AC (for power requirement see table above).

	Without booster	With booster
Australia	1x 220 - 240V AC 10A socket	2x 220 - 240V AC 10A sockets
UK	1x 220 - 240V AC 13A socket	2x 220 - 240V AC 13A sockets

### Water supply pressure requirements

Component	Min - Max pressure, kPA (bar)	
	Australia	UK
HydroTap	170 (1.7) - 700 (7.0)	170 (1.7) - 500 (5.0)
Vented Mixer Tap	300 (3.0) - 700 (7.0)	200 (2.0) - 500 (5.0)
Booster	200 (2.0) - 700 (7.0)	200 (2.0) - 500 (5.0)
Limescale filter	200 (2.0) - 700 (7.0)	200 (2.0) - 500 (5.0)



A pressure limiting valve must be fitted for mains water pressures above the maximum limits stated above in accordance with local plumbing regulations.

**Note:** All models (excluding UK) have an internal pressure limiting device to reduce the maximum mains regulated pressure (700kPa in Australia), protecting the system against pressure surges above 500kPa.

### Water supply connection

1/2" BSP (G1/2)

### Booster specification

Specification	Rating
Power 230V 50/60Hz	2.20kW
Power 240V 50/60Hz	2.40kW
Flow rate	1.2 L/min



## SECTION 5: Parts supplied

Parts supplied with the HydroTap	For Work	For Home
<b>Tap</b>		
HydroTap tap kit	✓	✓
Separate Mains mixer Tap kit	Optional	Optional
<b>Command Centre</b>		
Command Centre	✓	✓
Mains electrical supply cable	✓	✓
Water supply inlet hose	✓	✓
Water supply inlet adaptor and strainer	✓	✓
Ventilation kit	✓	✓
Water block kit	(UK only)	(UK only)
<b>Booster</b>		
Booster & hoses	Optional	✗
<b>Filters</b>		
Water filter & instructions	✓	✓
Limescale filter kit	Optional	Optional
<b>Font</b>		
Font kit	Optional	Optional

**Note:** Mains water isolation valve is not supplied with the kit.

Contact Zip for the full range of consumables and accessories.

## SECTION 6: Set up the ventilation



A clearance envelope around all Command Centres must be provided to allow ventilation for the safe and effective use of the HydroTap system.

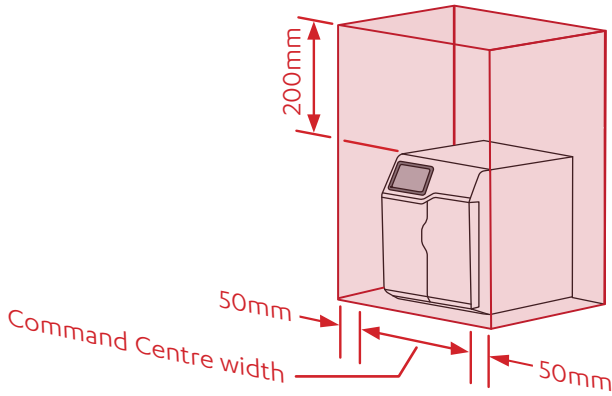

## SECTION 6: Set up the ventilation

### B60 - 100, BA60 - 100, B Home, BA Home models

- Cold air is drawn in through the inlet vent and lower gap provided by the door buffers.
- Warm air is exhausted through the upper gap provided by the door buffers.

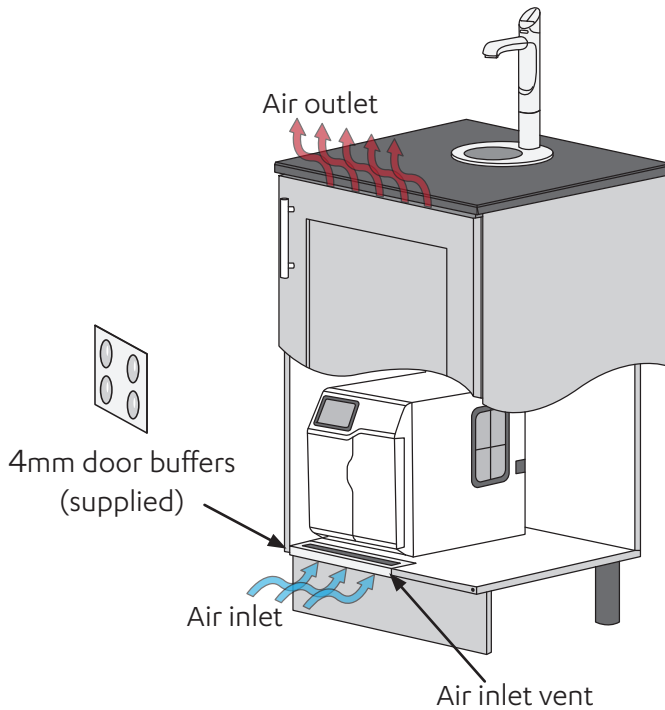

### All models

If cupboard temperature exceeds 35°C, additional ventilation is required. Contact your Zip service provider for options (including additional vents and fan kit).

## SECTION 7: Connect the water supply



**Valves and fittings must be sealed with PTFE tape if compression seals are not included.**

**Note** Mixer tap installations also use a 'Tee piece' as part of the water supply plumbing connections, see the Tap installation instructions supplied with the Mixer Tap to connect the water supply if using the mixer tap option.

**Note** correct strainer orientation.

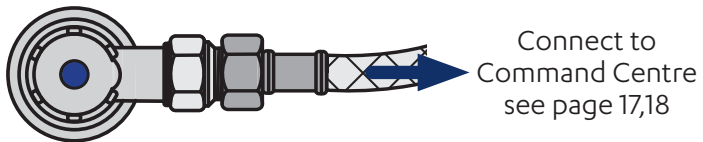
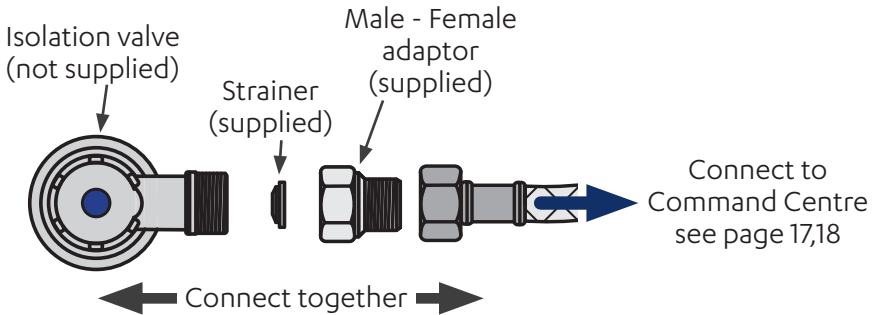

## SECTION 8: Set the bypass & install the Limescale filter

Available as optional accessory - UK only.



For filter head installation use the guide supplied with the filter head.

For Limescale filter installation use the guide supplied with the filter.



Flush filter before use.

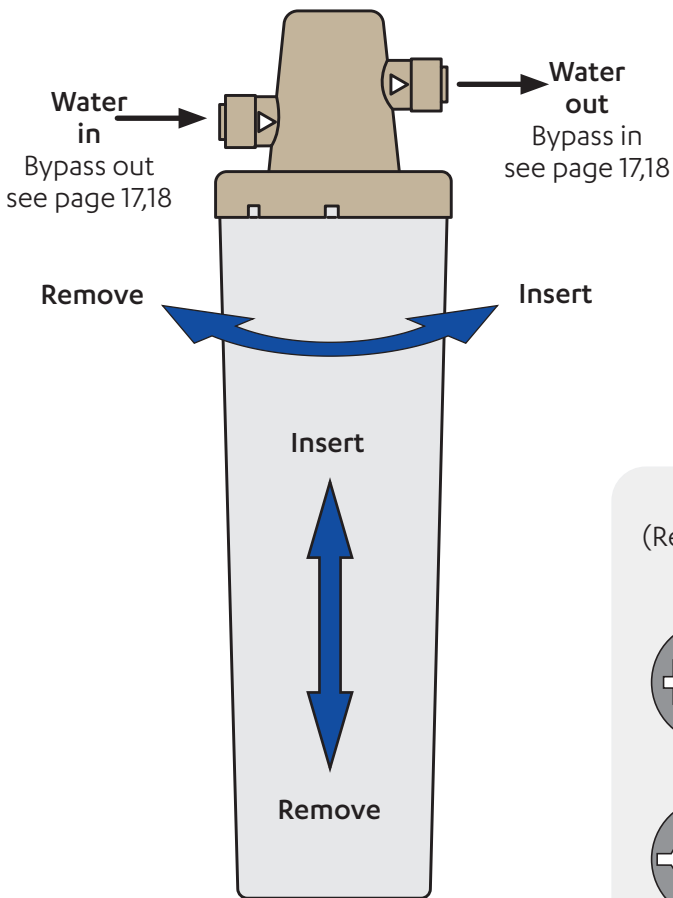

### Bypass valve

(Rear of the Command Centre)

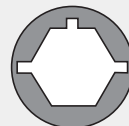
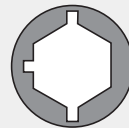

## SECTION 9: Fit the Booster

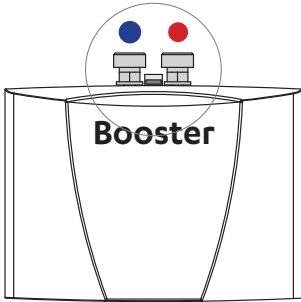

- Supplied with selected models, or available as an optional accessory.

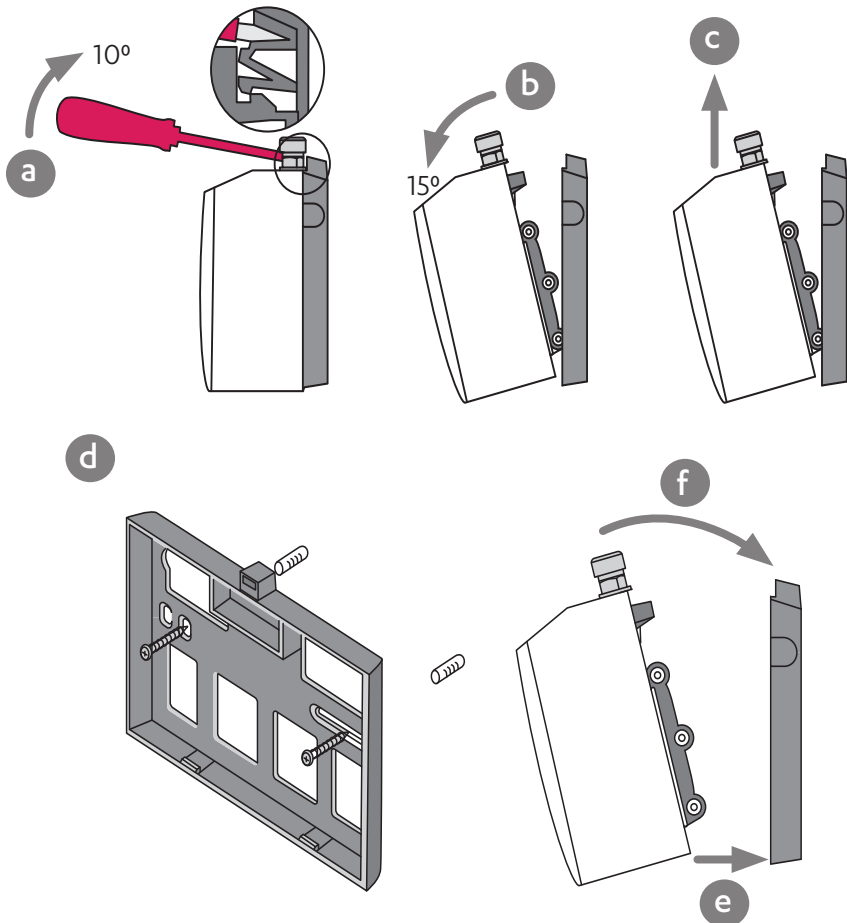

**Note** Take care not to break the clips when removing or installing the Booster.

## SECTION 10: Connect the Booster

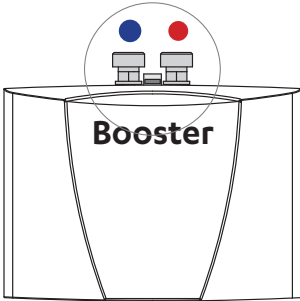

**Do not connect to electrical power until commissioning.**  
**Do not over tighten hose connections.**  
**Braided hoses supplied cannot be lengthened.**

Cold water into Booster,  
connect to Command Centre

BYPASS OUT  
see page 17,18

Hot water out of Booster,  
connect to Command Centre

BYPASS IN  
see page 17,18

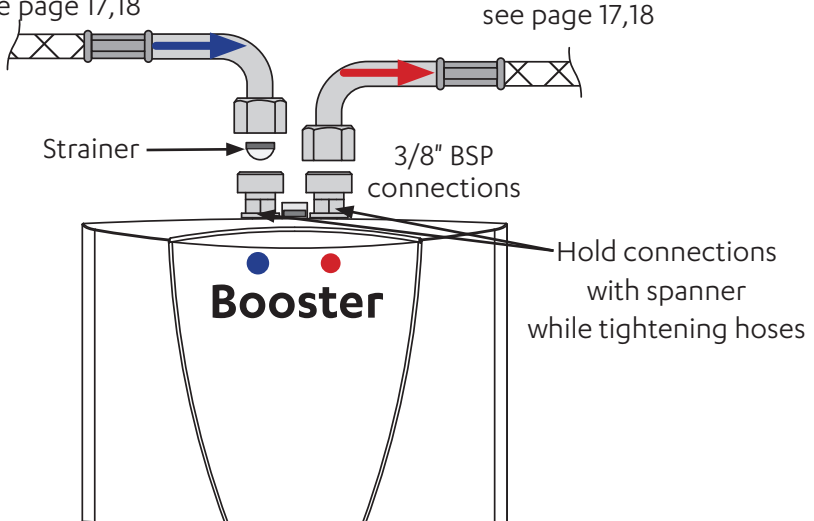

## SECTION 11: Connect the Command Centre

### Generic installation instructions



For HydroTap, mixer tap and any optional accessories, use instructions supplied with individual kit components.

#### Mains power cable

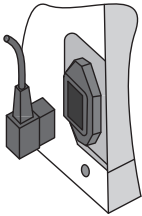

Do not connect to the mains socket until commissioning

#### USB

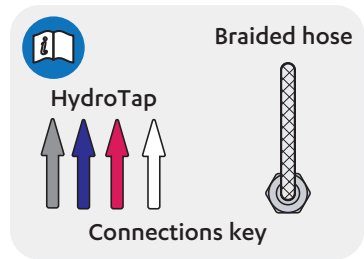
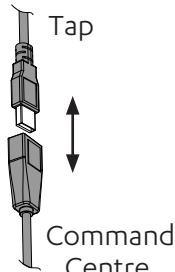

Installation diagrams are for illustrative purposes only.  
Hoses are not shown to scale and cannot be lengthened.

#### Tips for hose connection

- Push the silicone hose over the connector for a minimum of 15mm.
- Ensure there is a constant fall from the tap down to the command centre.
- Hoses must be trimmed to avoid loops and kinks. Take care when positioning before cutting and make a clean cut straight across the hose, using a sharp blade.
- The hoses must not be under tension when installed.

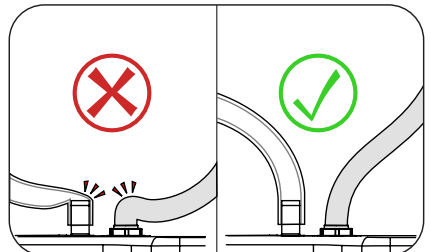
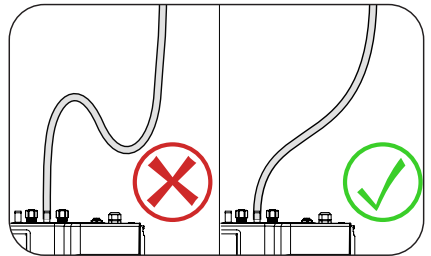



## SECTION 11: Connect the Command Centre

### B60, B100, B Home models

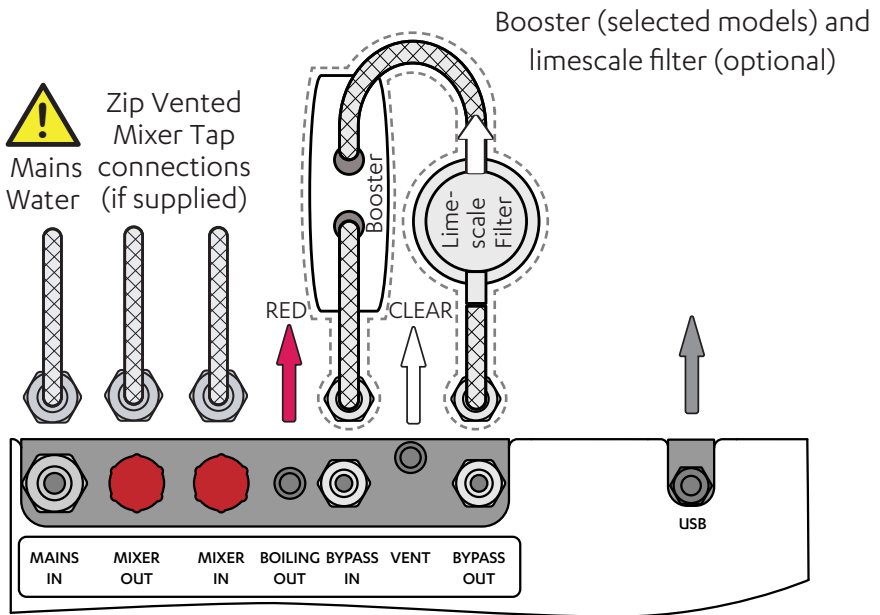

### Example installation

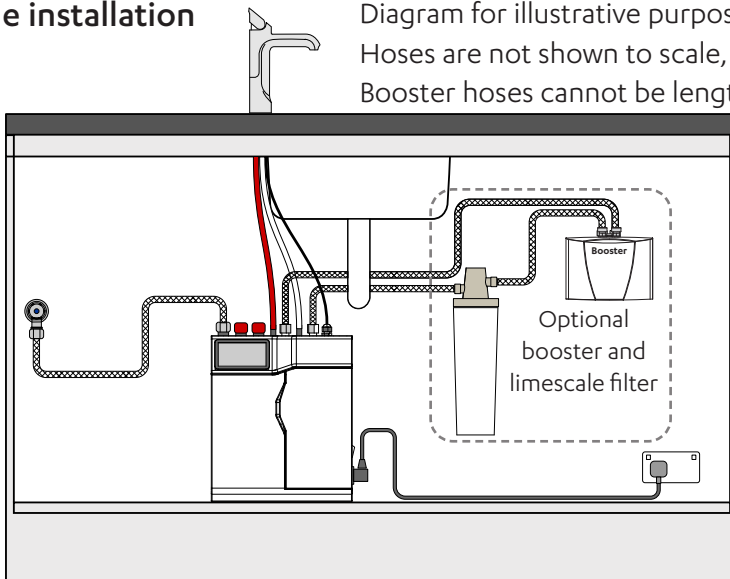

## SECTION 11: Connect the Command Centre

### BA60, BA100, BA Home models

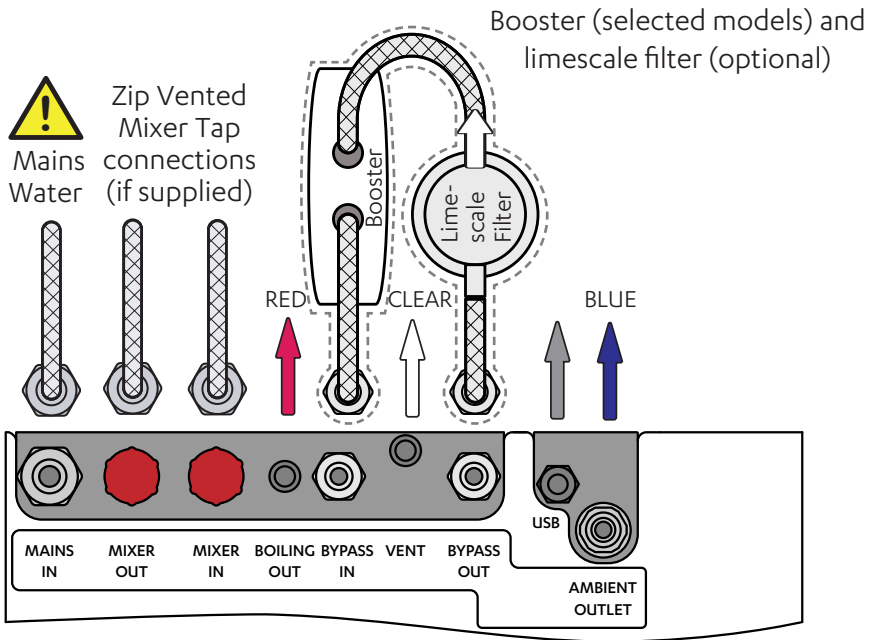

### Example installation

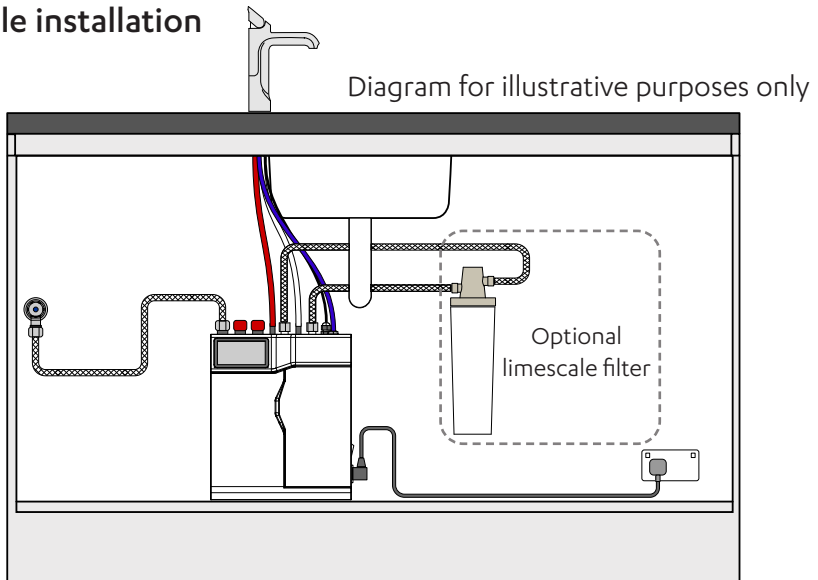

## SECTION 12: Commissioning



1  See User Guide

**Unpack, moisten o-rings & fit filter**

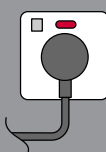
2  Connect electricity

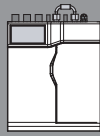
3  Monitor display screen

4  Set Language

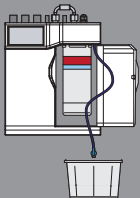
5 

5  Filter flush

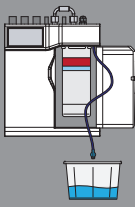
 Flush 10 Litres through

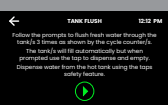
6  Tank flush

 Dispense water as instructed

7  Boiling calibration

8  Boost enable if Booster fitted

9  Power off  
Pull levers forward  
Power on

**Safety calibration (if required; Classic Tap only)**

Refer to User Guide for operation and maintenance.



**Zip Water UK**

Trafalgar House, Rash's Green,

Dereham, Norfolk, NR19 1JG

0345 6 005 005

[sales@zipindustries.co.uk](mailto:sales@zipindustries.co.uk)

[specify.zipwater.co.uk](http://specify.zipwater.co.uk)

